



Guldmann Mobile lifter GL5.2 – 80 mm castors

Technical specifications

Functions

Lifting capacity, max	: 155/205 kg
Lifting speed with 85 kg load	: 36 mm/sec
Number of lifts per charging	: 50 lift with 85 kg
Lifting interval	: 1302 mm

Operation

Lift	: Electric
Width adjustment	: Electric

Weight

Totally	: 44 kg
Chassis	: 22 kg
Mast + lifting boom	: 22 kg
Hand control	: 0.25 kg

Measurements

A.	: 44 mm
B.	: 118 mm
C.	: 1988 mm
D.	: 1340 mm
E.	: 393 mm
F.	: 630 mm
G.	: 1320 mm
H. min/max	: 640/1942 mm
I. min/max	: 431/1734 mm
J. min/max	: 530/1300 mm
K. min/max	: 695/1410 mm

Turning radius

Turning radius:	: 1460 mm
-----------------	-----------

Safety Features

Emergency stop	: Yes
Emergency lowering	: Yes, electronic. Mechanical on request
Protection against trapping	: Yes

Electrical parts

On/off	: Automatically
Integrated Power supply for charging	
Input	: 120-240Vac, 50-60 Hz, 30 VA
Battery, replaceable	: 25.2 V / 2.6 Ah
Charging time	: Max. 4 hours
Consumption/power of actuator	: 24V, max 8A
Duty Cycle	: Max 10%, max. 2 min on, 18 min off.
Battery protection	: Switches off automatically at low voltage. Diode light up to indicate critical voltage.

Class of tightness

Mobile hoist	: IP 30
Hand control	: IPX 4
Integrated Power supply	: IPX 6
Battery	: IPX 6
Actuator	: IPX 4

Accessories/ Miscellaneous

- Lifting hanger
- External charger

Labelling

The product is manufactured in compliance with regulation (EU) 2017/745 of the European parliament and of the Council of 5 April 2017, as medical device Class I.

Item Number/Model

562310	: 205 kg, 80 mm castors
562311	: 155 kg, 80 mm castors
562314	: 205 kg, 80 mm castors, manual lowering
562315	: 155 kg, 80 mm castors, manual lowering

Classified

acc. to ISO 9999	: 12 36 03
------------------	------------

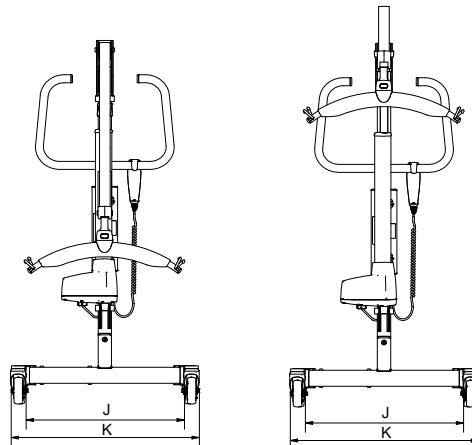
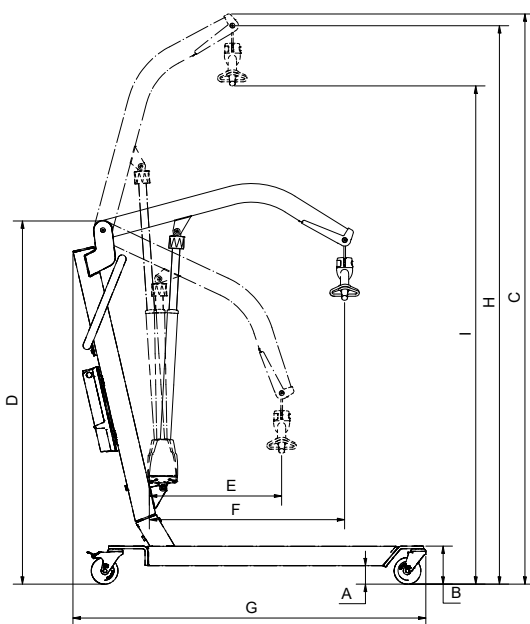

Time to care