



**Guldmann Inc.**  
Tel. 800 664 8834  
Tel. 813 880 0619  
Fax 813 880 9558  
info@guldmann.net  
www.guldmann.net

## Combi-lock Technical specifications

### Function

Usage : Ensures the joining of  
Guldmann rail systems

### Weight

Combi-lock : 4,6 lbs (2,1 kg)  
Safety lock  
on fixed rail : 2,42 lbs (1,1 kg)  
on traverse rail : 2,2 lbs (1,0 kg)

### Materials

Safety lock  
on fixed rail : Rustproof steel  
on traverse rail : Rustproof steel  
Covers : Plastic

### Measurements

A : 4½" (114 mm)  
B : 4" (99 mm)  
C1 : 7¾" (195 mm)  
C2 : 7" (175 mm)  
D1 : 11" (280 mm)  
D2 : 4" (100 mm)  
E : 4¾" (119 mm)

### Markings

The product is manufactured in compliance with regulation (EU) 2017/745 of the European parliament and of the Council of 5 April 2017, as medical device Class I.

### Item Number/Model

555237 : Combi-lock

### Patents

: Patent Pending  
Design Protected

Max 560 lbs  
(255 kg)

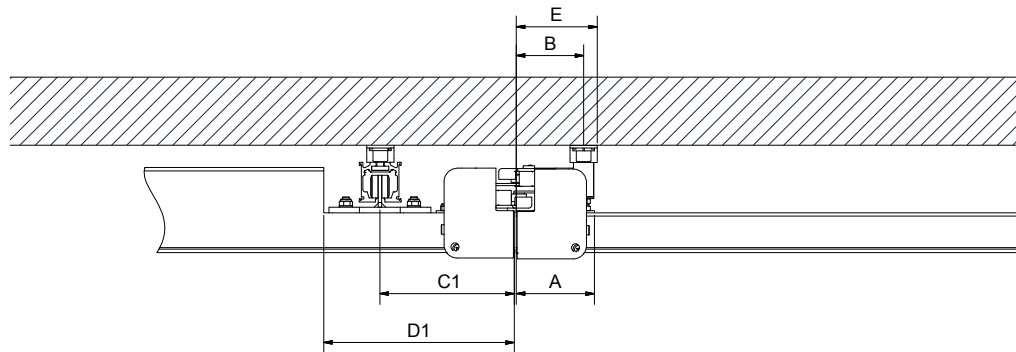

Max 825 lbs  
(375 kg)

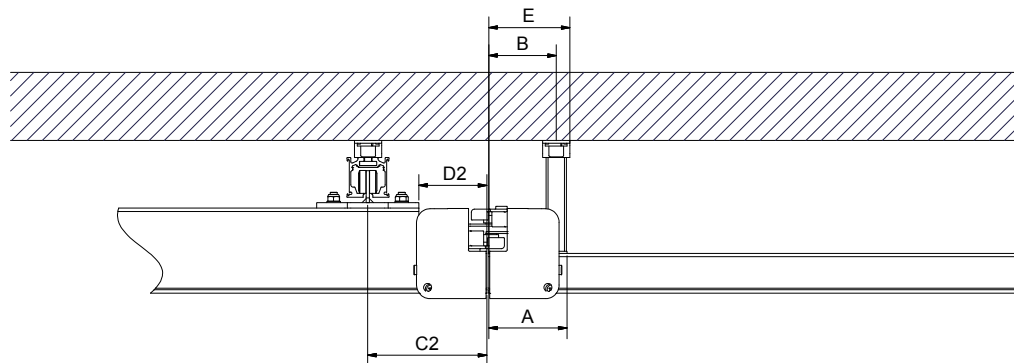

Time to care

Guldmann™